



The Cardinal Cappuccino Crystal Oscillator CMOS 10MHz - 250MHz

Features

- 2.5V or 3.3V supply voltage-configurable
- 10MHz to 250MHz CMOS outputs-configurable
- Better than 2Hz tuning resolution
- Low power, typically 20mA CMOS
- Temperature range: -40°C to +85°C
- Stability: ± 25ppm/ ±50ppm
- Phase Jitter (12kHz – 20MHz) .9ps RMS

Applications

- Multimedia
- Computing
- Networking, etc.

Part Numbering Example: CJA C 7 L Z - A7 BR - XXX.XXX TS

CJA	C	7	L	Z	A7	BR	XXX.XXX	TS
SERIES	OUTPUT	PACKAGE STYLE	VOLTAGE	ADDED FEATURES	OPERATING TEMP.	STABILITY	FREQUENCY	TRI-STATE
CJA	C = CMOS	2 = 2.5 X 2 5 = 5 X 3.2 7 = 7 X 5 .	S = 2.5V L = 3.3V	Z = Tape and Reel	A7 = -40°C to +85°C	BR = ± 25ppm BP = ± 50ppm BD = ± 20ppm		TS = Tri-State

Specification

Waveform	CMOS
Frequency	10MHz to 250MHz
Operating Temperature Range	-40°C to +85°C
Storage Temperature Range	-55°C to +125°C
Supply Voltage	2.5V, 3.3V
Frequency Stability vs. Temp. Range	±25ppm/ ±50ppm
Input Current	40mA
Rise/ Fall Time	4ns
Phase Jitter	.9ps Typical
Duty Cycle	48/52
Start-Up Time	10ms Max
Enable/ Disable Input Voltage	VIH ≥ 0.7VDD or No Connection, VIL ≤ 0.3VDD or Ground
Output Load	15pF
Aging/ Year	±3ppm Max

Description

The Cardinal Cappuccino crystal oscillator is based on a high performance integrated circuit designed for use in Cardinal’s continued expanding leadership products in the programmable frequency control industry. Cardinal’s new Cappuccino design is today state of the art in oscillators. The Cappuccino line product features 10MHz to 1.5GHz with CJAC ranging 10MHz to 250MHz Output, 2.5V or 3.3V Supply Voltage, CMOS commercial -20°C to +70°C and industrial temperature range -40°C to +85°C.

Cardinal’s new CJAC series is competitively priced and has the lowest typical power consumption 20mA CMOS (70% less power than the Fox XpressO™ oscillator), lowest jitter and best phase noise over 10kHz to 20MHz verses the traditional fixed frequency quartz oscillators and Surface Acoustic Wave oscillators. Cardinal’s programming centers utilize modern robotics, for testing, programming and 100% final testing as we do with all our programmable offerings. The Cardinal CJAC series line is offered in both ceramic and low cost plastic industry standard packages.

Cardinal’s Cappuccino line fits in all applications requiring a reference frequency including Multimedia, Computing, Networking, consumer etc.

Absolute Maximum Ratings

Item	Symbol	Condition	Unit
Input Voltage	V _I	-0.5 to V _{DD} + 0.5	V
Output Voltage	V _O	-0.5 to V _{DD} + 0.5	V
Positive Supply Voltage	V _{DD}	4.2	V
Storage Temperature		-55 to +125	°C



DC Electric Characteristics (T = 25°C)

Unless stated otherwise, the data presented here was taken over the following parameters, $V_{DD} = 3.3V \pm 10\%$ or $2.5V \pm 5\%$, $T_a = -40^\circ C$ to $+85^\circ C$ (industrial)

Item		Symbol	Specification			
			Min	Typ	Max	Units
Power Supply (V_{DD} , GND pins)	Power Supply Voltage	V_{DD}	2.97	3.3	3.63	V
		V_{DD}	2.375	2.5	2.625	V
	CMOS I_{DD}	I_{DD}		20	40	mA
	Current w/Output Disabled	I_{OED}		16		mA
	Rise Time	T_{VDD}	100			μS
Output Enable Function OE Pin Input LVCMOS/ LVTTTL	Input High Voltage	V_{IH}	$0.7 * V_{DD}$			V
	Input Low Voltage	V_{IL}			$0.3 * V_{DD}$	V
	Input High Current	I_{IH}			5	μA
	Input Low Current	I_{IL}	-10			μA
	Equivalent Internal Pullup Resistance	R_{PULLUP}		900		$\kappa\Omega$

Item		Symbol	Specification			
			Min	Typ	Max	Units
AC Characteristics						
Outputs						
LVCMOS/ LVTTTL (Out)	Frequency Range	F_{CMOS}	10		250	MHz
	Stability		-25		+25	ppm
	Operating Temperature		-40		+85	$^\circ C$
	Output High Voltage	V_{OH}	$.9 * V_{DD}$			V
	Output Low Voltage	V_{OL}			$.1 * V_{DD}$	V
	Duty Cycle	ODC_{CMOS}	45		55	%
	Rise Time	t_R	300		600	ps
	Fall Time	t_F	300		600	ps
OE Turn On Time (<50MHz)		$OE_{LOW/HIGH}$			200	ns
OE Turn On Time (>50MHz)		$OE_{LOW/HIGH}$			100	ns
OE Turn Off Time		$OE_{HIGH/LOW}$			50	ns
Jitter	Phase Jitter (12kHz to 20MHz)	tjit	0.4	0.9	1.5	ps rms
	Period Jitter	$t_{RMS, CMOS}$		2.5	3	ps
		$t_{p-p, CMOS}$		22	30	ps

Performance Characteristic Curves

Unless otherwise specified, data is characterized over temperature range -40°C to +85°C and voltage range 2.2V - 3.63V.

I_{DD} vs. V_{DD}

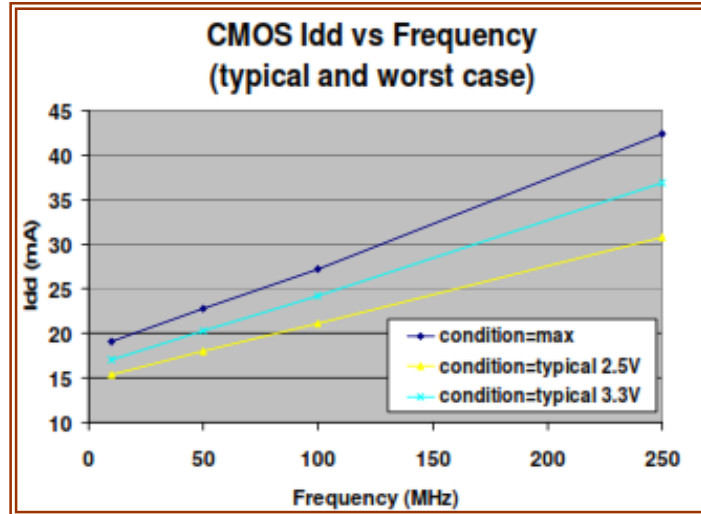

Figure 1. CMOS I_{DD} vs. Frequency, V_{DD}

OE Turn-on and Turn-off Times

Notes:

- These measurements were all performed with an AC coupled output so that leakage currents do not affect the timing of the measurement. This results in all waveforms floating to the midpoint of the signal levels when off.
- When CMOS is disabled the output goes to a Tri-State level.

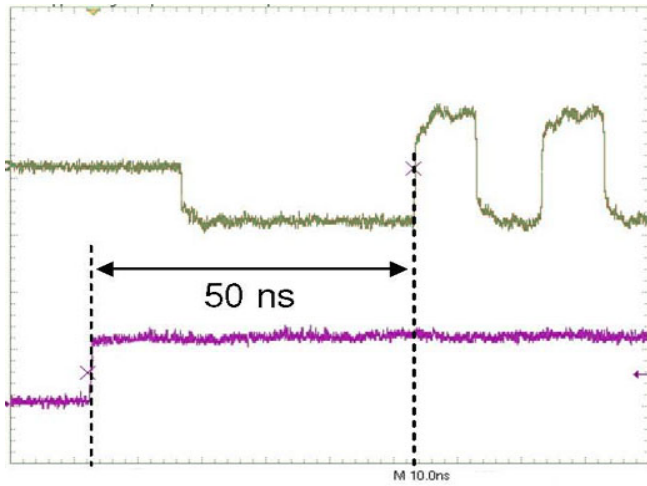

Figure 2. 2.5V CMOS OE Enabled Time

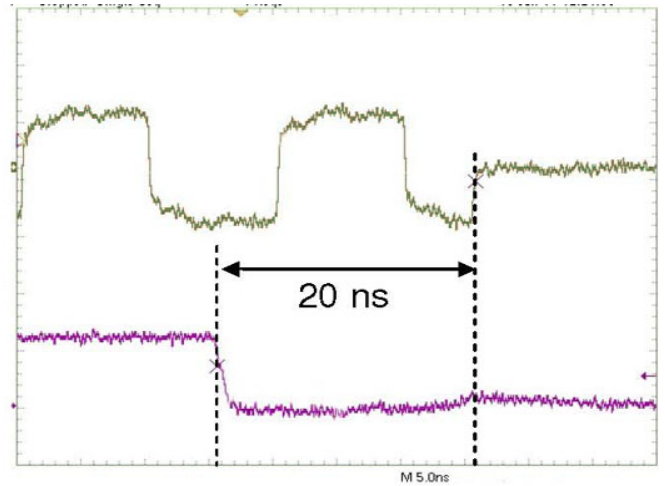

Figure 3. 2.5V CMOS OE Disabled Time

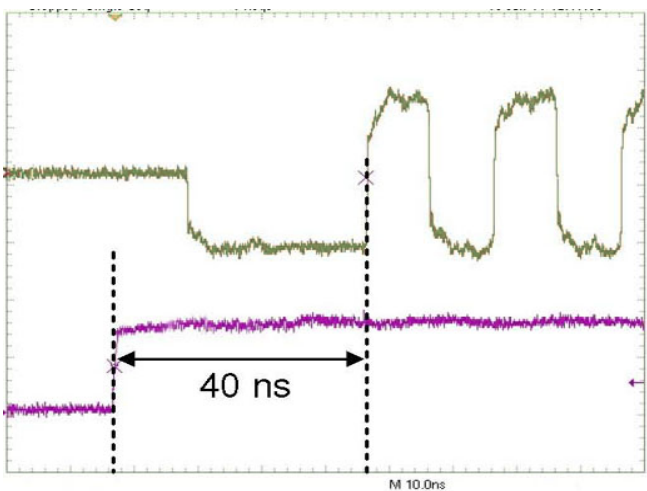

Figure 4. 3.3V CMOS OE Enabled Time

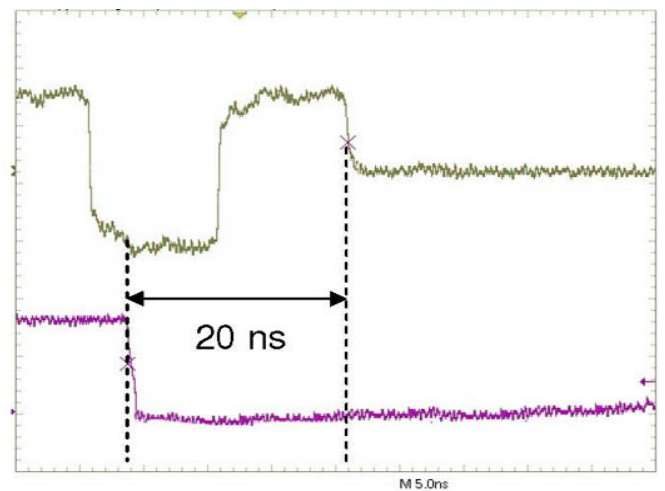

Figure 5. 3.3V CMOS OE Disabled Time

Waveform Measurements

The following figures are descriptions for how the waveforms are measured for the datasheet applications.

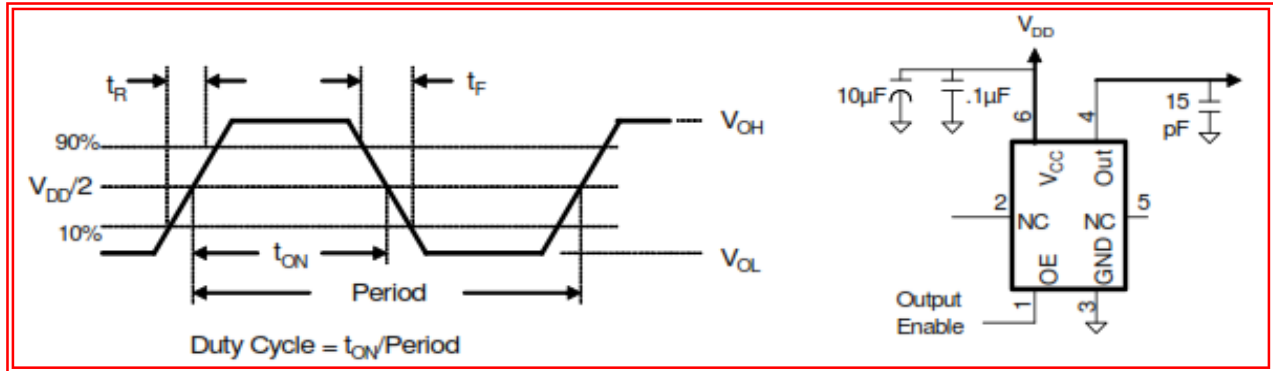
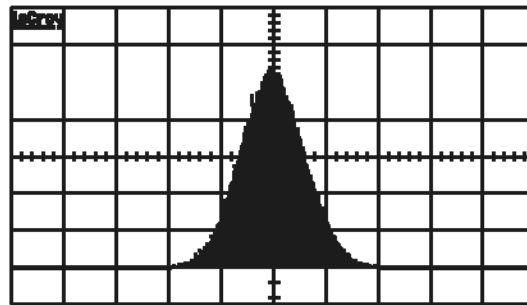

Figure 6. CMOS waveform measurement test setup

Phase Noise & Jitter Plots

11-Feb-13
22:48:11
①:Hp@lv(2)
5 ps
200 s
+8Z/+8Z
In 155400



50MHz CLOCK
Select
Measurement
View

acquire mode
Single
acquire
18.88 ps

00
ACQUISITION

μ@lv(2) 0.138 ns
low(B) 0.41447 ns
high(B) 0.41472 ns
range(B) 38.258 ps
sigma(B) 3.854 ps

1 ps
1 trig only
2 83MHz 800 s
3 disabled
4 trig only

2 00 -13MHz

8 09/s
U STOPPED

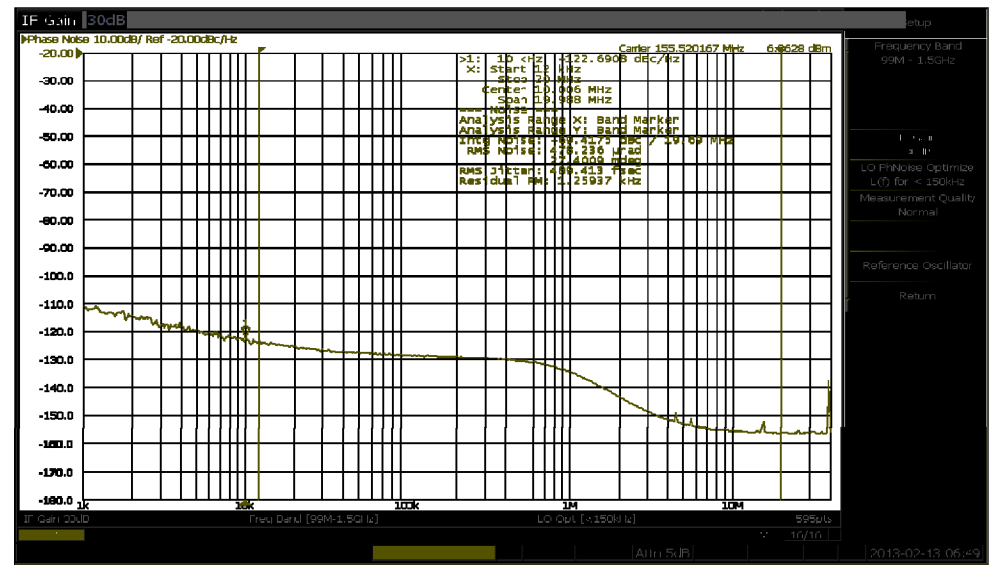
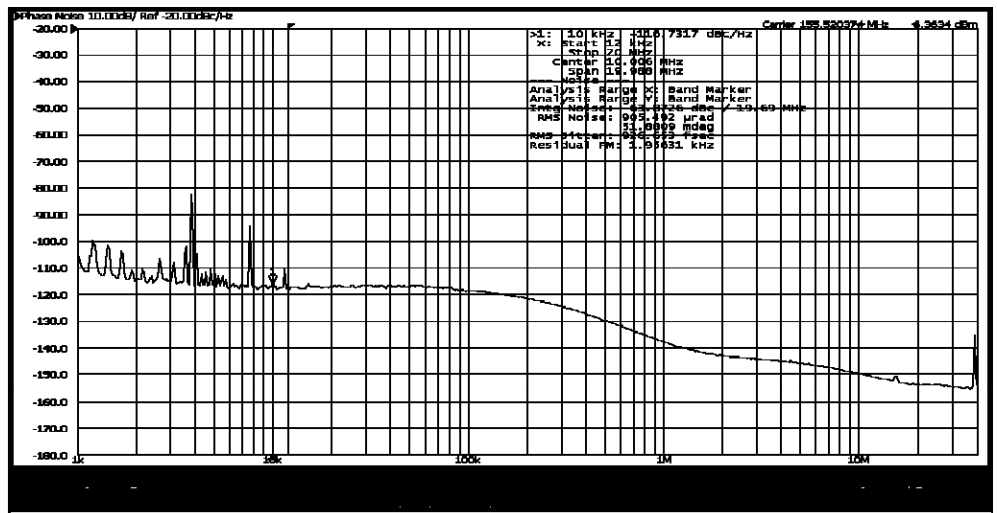

Recommended Solder Profile for
 Cardinal Components, Inc.
 Package Infrared Reflow.
 Do Not Use Ultrasonic-Wave Soldering or
 Wave Solder with Package Immersed in Solder
 Damage to Crystal will result.

CJAC 10MHz - 250MHz

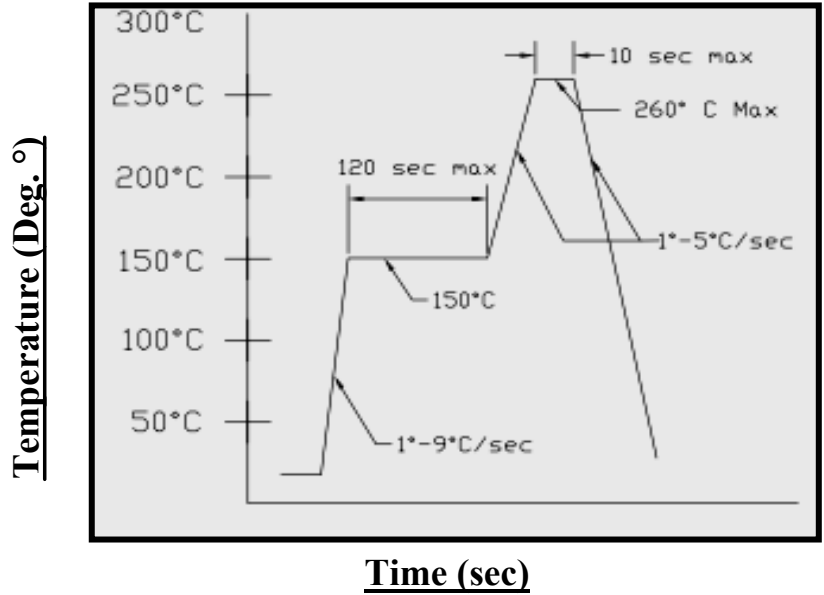

Reliability

Cardinal Components, Inc., qualification includes aging at various extreme temperatures, shocks and vibration, temperature cycling, and IR reflow simulation. The Cappuccino family meets the following qualification tests:

Environmental Compliance	
Parameter	Conditions
Mechanical Shock	MIL-STD-883, Method 2002
Mechanical Vibration	MIL-STD-883, Method 2007
Solderability	MIL-STD-883, Method 2003
Gross and Fine Leak	MIL-STD-883, Method 1014
Resistance to Solvents	MIL-STD-883, Method 2016
Moisture Sensitivity Level	IPC/ JEDEC J-STD-020, MSL1

Handling Precautions

Although ESD protection circuitry has been designed into the Cappuccino proper precautions should be taken when handling and mounting. Cardinal employs a human body model (HBM) and a charged-device model (CDM) for ESD susceptibility testing and design protection evaluation.

ESD Ratings		
Model	Minimum	Conditions
Human Body Model	1000V	MIL-STD-883, Method 3015
Charged Device Model	900V	JEDEC, JESD22-C101
Machine Model	200V	JEDEC, JESD22-A115-A

Style 7: 5x7mm

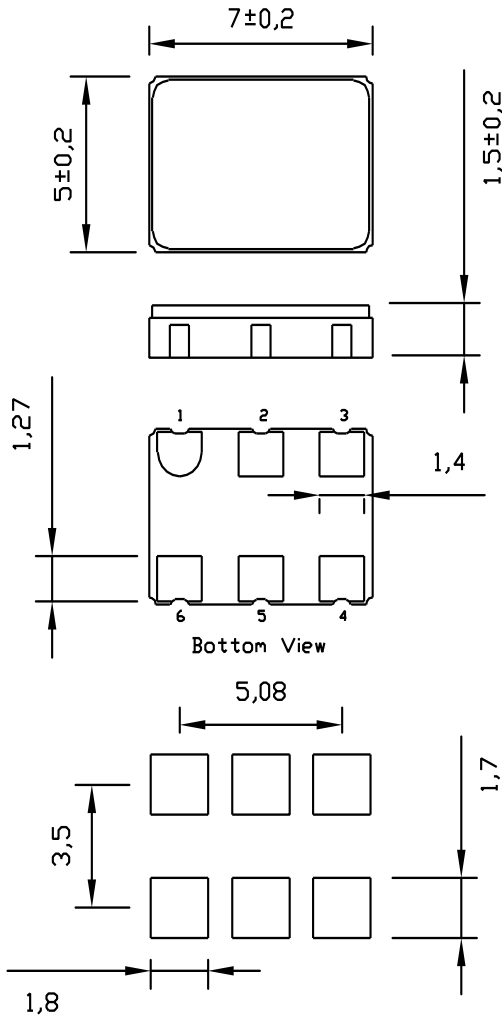

Style 5: 5x3.2mm

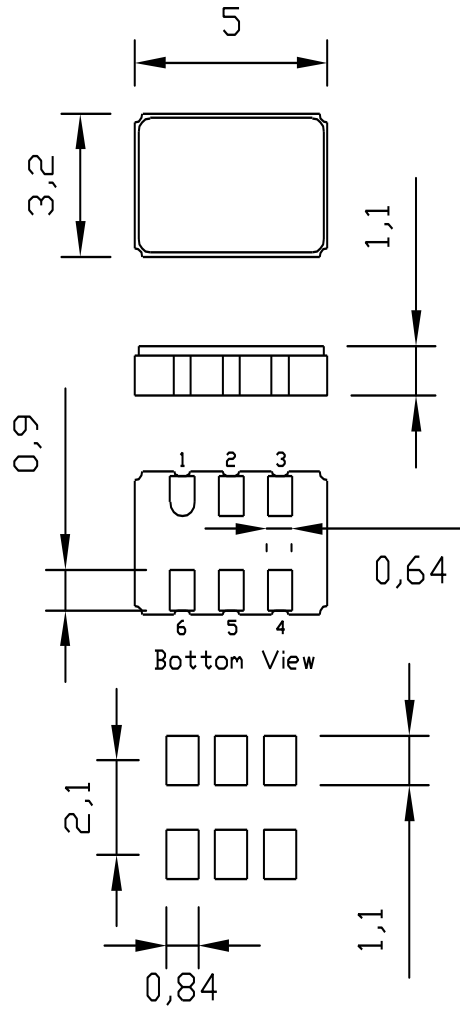

Style 2: 2.5 X 2 mm

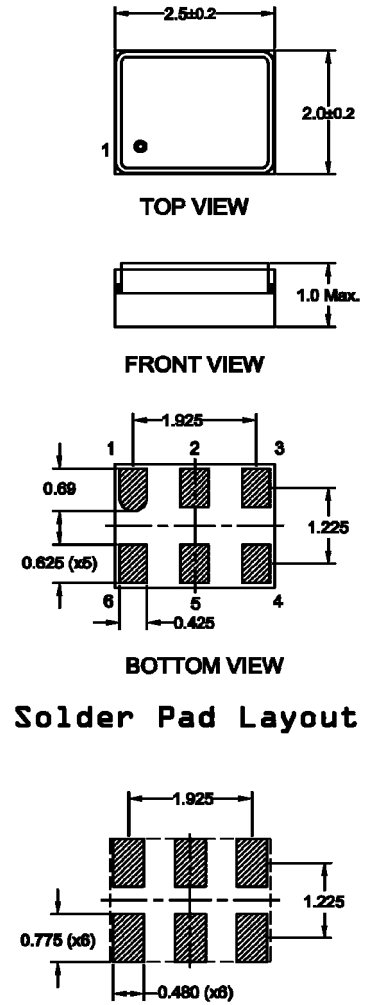

6 Pad CMOS

Pin 1	OE
Pin 2	Do Not Connect
Pin 3	GND
Pin 4	Out
Pin 5	Do Not Connect
Pin 6	V _{DD}

6 Pad CMOS

Pin 1	OE
Pin 2	Do Not Connect
Pin 3	GND
Pin 4	Out
Pin 5	Do Not Connect
Pin 6	V _{DD}

6 Pad CMOS

Pin 1	OE
Pin 2	Do Not Connect
Pin 3	GND
Pin 4	Out
Pin 5	Do Not Connect
Pin 6	V _{DD}

Tape and Reel Specifications

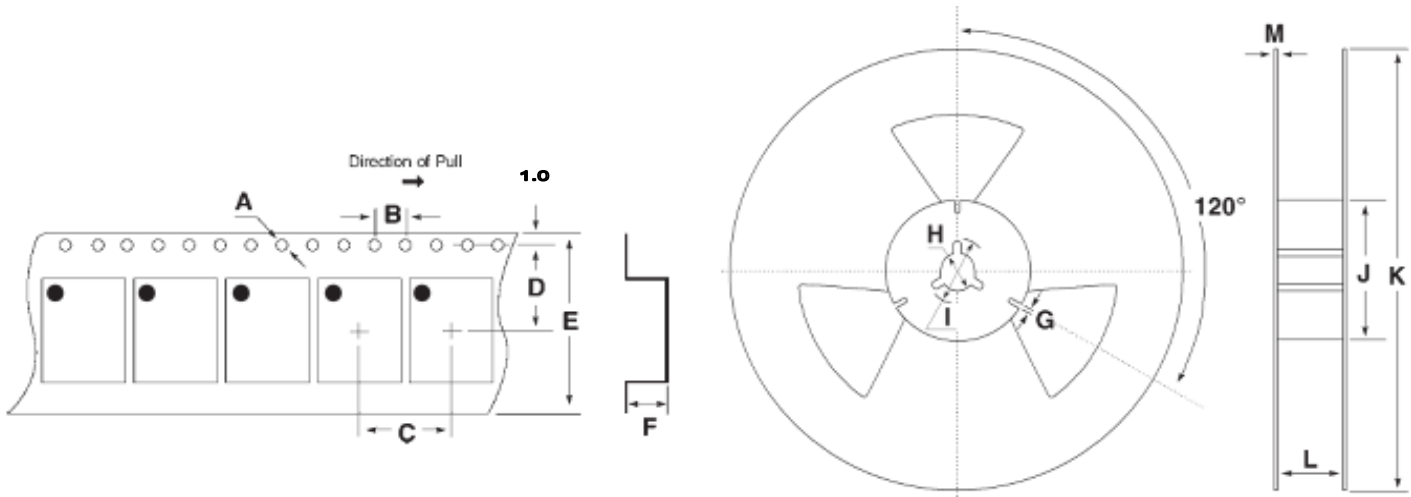

Tape Specifications (mm)

Package	A	B	C	D	E	F	QTY
2 = 2.5 X 2	1.5	4.0	4.0	3.5	8.0	1.1	1,000
5 = 5 X 3.2	1.5	4.0	8.0	5.5	12.0	1.8	1,000
7 = 7 X 5	1.5	4.0	8.0	7.5	16.0	2.2	1,000

Reel Specifications (mm)

Package	G	H	I	J	K	L	M
2 = 2.5 X 2	2.0	13	21	60	180	9.0	1.8
5 = 5 X 3.2	2.0	13	21	60	180	13.0	1.25
7 = 7 X 5	2.0	13	21	60	180	17.0	1.25