

FEATURES

- Frequency Range 10kHz to 600kHz
- High shock resistance
- Low ageing
- Designed for low power applications
- Full MIL testing available

DESCRIPTION

CX1HSM crystals consist of a high quality tuning fork resonator in a rugged, hermetically sealed ceramic package. CX1VSM is intended for use in Series (two cascaded inverters) oscillator circuits.

SPECIFICATION

Specifications stated are typical at 25°C unless otherwise indicated. Specifications may change without notice.

Frequency Range:	10.0kHz to 600.0kHz
Standard Calibration Tolerance*:	see table
Motional Resistance (R ₁):	Figure 1 Max = 10~169.9kHz, 2x typical 170~600kHz, 2.5x typical
Motional Capacitance (C ₁):	Figure 2
Quality Factor (Q):	Figure 3 Min. is 0.25x typical
Shunt Capacitance (C ₀):	2.0pF max.
Drive Level	
10~24.9kHz:	1.5μW max.
25~600.0kHz:	3.0μW max.
Turning Point (T ₀)**:	Figure 4
Temperature Coefficient (k):	-0.035ppm/°C ²
Ageing, first year:	5ppm max.
Shock, survival***:	1,000g, 1ms, ½ sine
Vibration, survival***:	20g rms, 10~2000Hz
Operating Temperature Range	
Commercial:	-10° to +70°C
Industrial:	-40° to +85°C
Military:	-55 to +125°C
Storage Temperature Range:	-55° to +125°C
Maximum Process Temperature:	+260°C for 20 seconds

- * Tighter frequency calibration is available.
- ** Other turning point is available
- *** Higher shock and vibration survival is available

PACKAGING OPTIONS

CX1HSM crystals are available either tray packed (<250pcs) or tape and reel (>250 pieces).
16mm tape, 178mm or 330mm reels (EIA 418).

HOW TO ORDER CX1HSM CRYSTALS

CX1H - S - C - SM1 - 32.768K 30 / I

'S' if special, custom design. Otherwise leave blank

Blank = glass lid
C = ceramic lid

Terminations
SM1 = Gold plated *
SM2 = Solder plated
SM3 = Solder dipped
SM4 = Solder plated *
SM5 = Solder dipped *
* = Lead free

Frequency
K = kHz

Calibration Tolerance
@25°C
(in ppm)

Temp. Range
C = -10° ~ +70°C
I = -40° ~ +85°C
M = -55° ~ +125°C
S = Customer specified

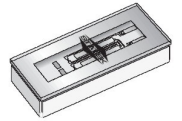

OUTLINE & DIMENSIONS

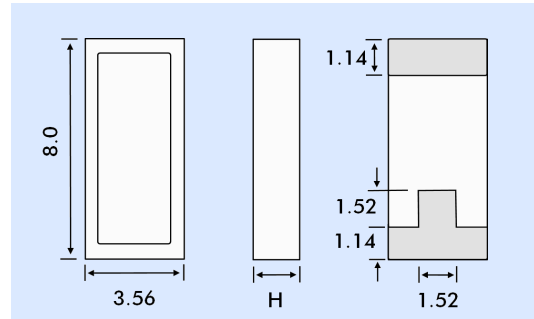

DIMENSION 'H'

Terminations	Glass Lid	Ceramic Lid
SM1	1.65	1.78
SM2/SM4	1.70	1.83
SM3/SM5	1.78	1.90

STANDARD CALIBRATION TOLERANCE

Frequency Range (kHz)			
10~74.9	75~169.9	170~249.9	250~600
±30ppm (0.003%)	±50ppm (0.005%)	±100ppm (0.01%)	±200ppm (0.02%)
±100ppm (0.01%)	±100ppm (0.01%)	±200ppm (0.02%)	±500ppm (0.05%)
±1000ppm (0.1%)	±1000ppm (0.1%)	±2000ppm (0.2%)	±5000ppm (0.5%)

SUGGESTED SOLDERING PATTERN

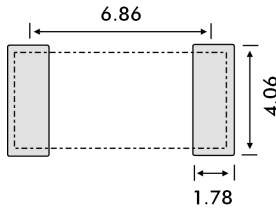

CRYSTAL EQUIVALENT CIRCUIT

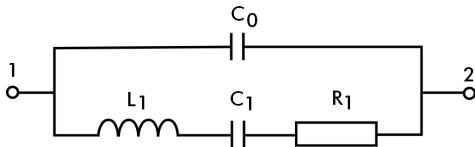

R1 Motional Resistance L1 Motional Inductance
 C1 Motional Capacitance C0 Shunt Capacitance

CONVENTIONAL SERIES OSCILLATOR CIRCUIT

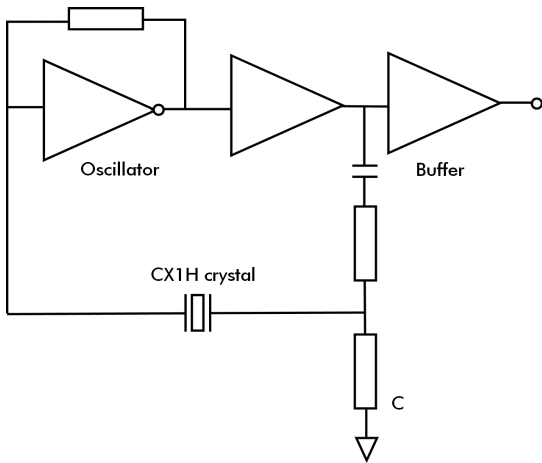

TERMINATIONS - PLATING

Designation	Termination
SM1	Gold Plated (Lead Free)
SM2	Solder Plated
SM3	Solder Dipped
SM4	Solder Plated (Lead Free)
SM5	Solder Dipped (Lead Free)

Turning Point Temperature

Note: Frequency f at temperature T is related to frequency F0 at turning point temperature To by:

$$\frac{f \cdot f_0}{f_0} = k(T - T_0)^2$$

**FIGURE 1
CX1H Typical Motional Resistance R1**

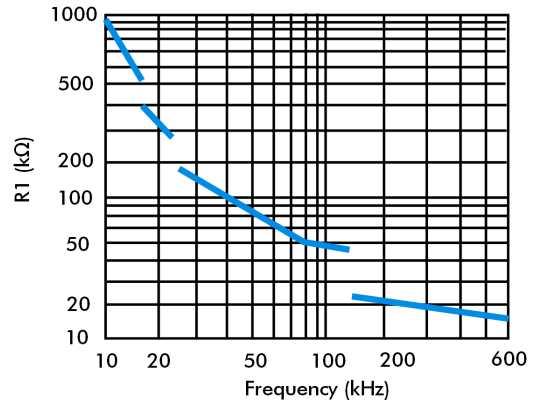

**FIGURE 2
CX1H Typical Motional Capacitance C1**

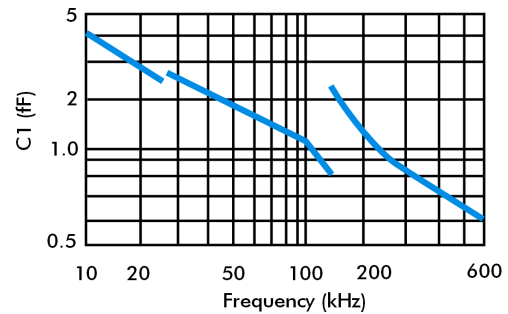

**FIGURE 3
CX1H Typical Quality Factor (Q)**

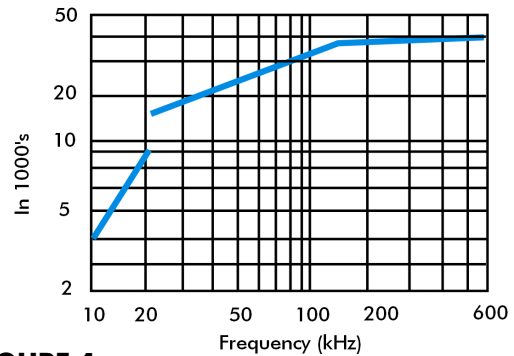

**FIGURE 4
CX1H Typical Turning Point Temperature (To)**

