

# QTM38T Series

## 3.0x8.0 Metal Cylindrical Tuning Fork



### Features

- An industry-standard source of 32.768kHz clock signals
- Excellent shock resistance and environmental capability
- RoHS compliant by exemption
- A high build quality component at low cost

### General Specifications

Nominal Frequency	32.768 kHz
Frequency Tolerance at 25°C	±20ppm
Temperature Coefficient	-0.034ppm/Δ °C <sup>2</sup>
Temperature Range (Operating)	-40 to +85°C
Storage Temperature	-55 to +125°C
Load Capacitance C <sub>L</sub>	6.0pF, 12.5pF
Shunt Capacitance C <sub>0</sub>	1pF typ.
Motional Capacitance C <sub>1</sub>	2.5fF typ.
Equivalent Series Resistance (ESR)	50KΩ max.
Drive Level	1μW max.
Aging per Year	±3ppm max.
Insulation Resistance (M Ω)	500mΩ min.
Quality Factor	80000 typ.
Capacitance Ratio	400 typ.
Resistance to Shock	±5ppm maximum offset from 75cm drop test in all axes on to a hard surface
Turnover Temperature	25°C ±5°C

### Mechanical Dimensions

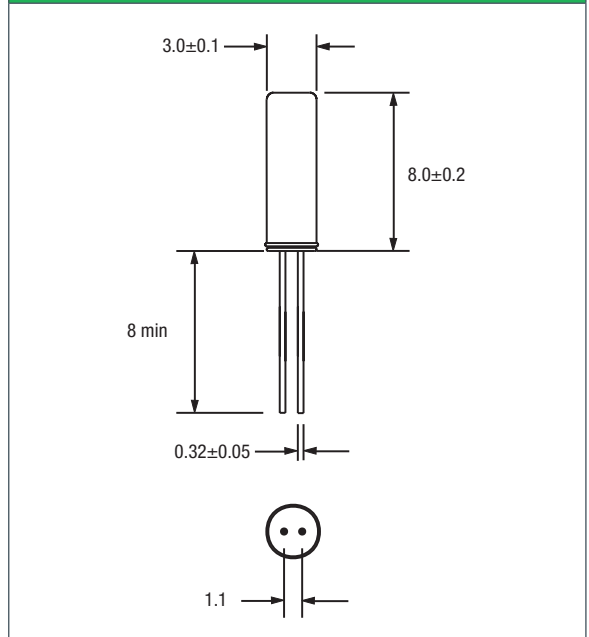

### Part Numbering Guide

Qantek Code	Package	Nominal Frequency (in kHz)	Load Capacitance	Operating Temperature Range	Frequency Tolerance	Packaging
Q = Qantek	TM38T = 3.0x8.0 Metal THT	32.768	06 = 6pF 12 = 12.5pF	<b>B = -40 to +85°C</b>	<b>2 = ±20ppm</b>	B = Bulk (1000 pcs/bag)
Example: QTM38T32.76812B2B					bold letters = recommended standard specification	

### Marking Code Guide

Contains manufacturer code / lot code

### Solder Reflow Profile

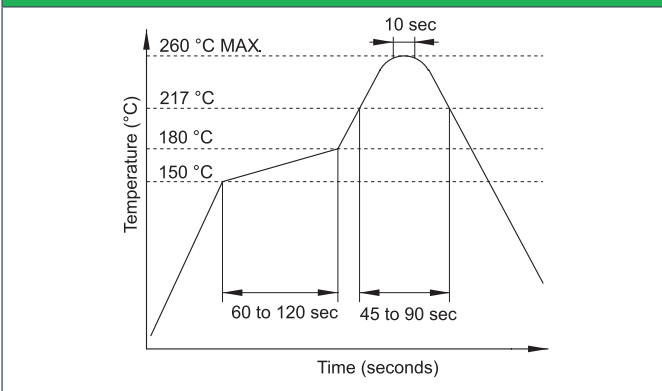

### Frequency vs. Temperature Characteristics

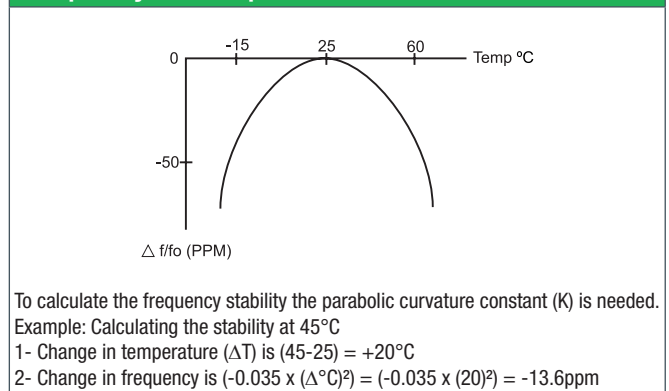

**QANTEK Technology Corporation**

Phone: +1 877-227-0440 (tollfree)

Fax: +1 877-227-0440 (tollfree)

www.qantek.com

info@qantek.com